



MEET THE BETTER IDEAS

**REYMANN
TECHNIK** 

RATEC
MEET THE BETTER IDEAS

CONTENTS

Introduction	03
RATEC services	04–07
Magnets/MTK	08–09
Formwork and LLC (RATEC USA)	10–11
upcrete® special formwork	12–13
upcrete® modular housing	14–15
Reymann Technik	16–17
Contacts	18–19

REYMANN TECHNIK	RATEC	MTK
development and engineering	construction and production	production
BUSINESS ESTABLISHMENTS		
RATEC LLC (USA) RATEC S.L.U. (Latin America) RATEC OOO (Russia)		
DISTRIBUTION LOCATIONS		
Netherlands and Belgium, Great Britain, France, Italy, Spain, Portugal, Austria, Denmark, Sweden and Norway, Iceland, Ukraine, Uzbekistan, Turkey, India, United Arab Emirates, South Africa, Japan, Belarus		



WE HAVE A LONG TRADITION OF COMING UP WITH BETTER IDEAS.

Andreas and Jörg Reymann

A success story over two generations.

The next generation: Mathias, Andreas and Jörg, sons of company founder Wolfgang Reymann, are steadily building on the know-how the company has been developing for over 40 years.

Over the past 40 years, a one-man engineer's office has grown into a whole group of companies whose ideas and products have revolutionised the entire precast concrete industry.

Their ambitious focus on the best possible outcome for their clients has proven to push the boundaries with a diverse outlook on production procedures over and over again. The passion and drive towards a constant improvement of their products emphasizes our highly skilled engineering expertise and fuels our creativity and strategic approach to think ahead of time.

Today the group of companies has over 70 employees, two production facilities, a worldwide distribution net-

work and a burgeoning tradition of offering innovative and economic solutions for the rationalisation in the production of precast concrete elements.

Reymann Technik not only develops pioneering rationalisation solutions but we also perform as a project developer to ensure a smooth execution of the transition progresses throughout the entire production concrete plant. On these foundations, RATEC transforms ideas into reality – economically, individually and down to the last detail.

This unique blend is what characterises the system and people behind these better ideas.



**STRATEGY AND PASSION
DETERMINE THE FOUNDA-
TIONS OF MARKET-
ORIENTED SOLUTIONS**

Jörg Reymann, Managing Director



For over 40 years Reymann group has been developing and producing better ideas at its Hockenheim centre, from individual solutions to mass production.

Today's solutions to individual challenges become tomorrow's reality.

Reducing production costs and increasing the quality of the finished elements. These are the real objectives which determine our thoughts and deeds. And our customers' success.

RATEC sets high standards which have manifestly proven their worth when it comes to individual solutions. The value of profit that will be generated by committing to use our framework components can be precisely calculated. You will benefit from our wide ranging industry experience, advisory service as well as our professional consulting expertise. For our clients we will not settle for less than satisfactory.

At RATEC we combine and execute the outstanding ideas generated by the Reymann Group. In our inter-knitted environment we develop and optimise a wide range of customer related projects. We provide special attention

to perfectionise the relationship between production processes and the corresponding precast concrete plants to guaranty a production set up that will generate a smooth workflow for each individual client.

By combining our skills, expertise and experience we are proud to offer successful solutions to very specific challenges that have proven their place in the world marked with a variety of our system components. This specific approach to custom adaptations combined with our variety of high quality standard products are tailored to satisfy the individual needs of our customers in an extremely economical and reliable manner.

FROM THE IDEA TO MARKET READINESS



In-house engineering and production guarantee **well-thought-out solutions**, down to the last detail.

By concentrating on advanced solutions in the formwork technology of precast concrete plants, RATEC components and formwork systems have come to set industry standards all round the world.

Drawing on over 40 years of Reymann Technik planning and development expertise, our engineers constantly work on solutions that improve our framework technology and rationalize its application.

Putting our ideas into practice we focus on reliability, durability and economy of our products and deliver outstanding craftsmanship to produce our high quality precast concrete elements.

We have also raised the standards though introducing extremely powerful precision magnets to position and fix the formwork. We offer cutting edge technology which delivers the greatest possible flexibility within our variety of modular systems and magnets, with or without activation mechanisms, plus adaptor solutions, fine-tuned

detail solutions for recesses, anchorages and spacers, plus formwork systems for individual applications. We execute special individual solutions extremely economically and rapidly.

While researching and developing new efficient product solutions we invest in a wide ranging study of existing and new resources as well as consulting a valuable range of expertise. Our goal is to constantly improve and rationalize the products that we offer to suit our clients as a whole as well as providing the perfect set up for very specific inquiries. This has facilitated innovations such as the switchable magnets, the integration of magnets into the formwork system and significant improvements in the magnets' weight-power ratio through our scientific knowledge of the materials with which we work daily.

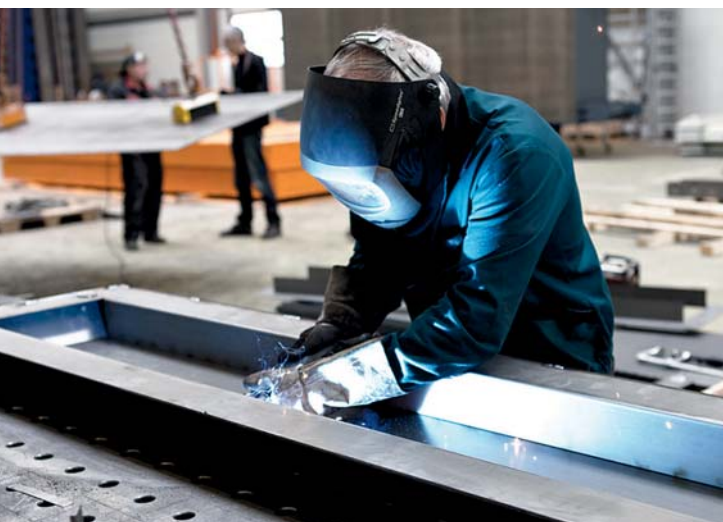

PRODUCTS AND SERVICES **RATEC**

- Formwork magnets
- Formwork systems
- Formwork handling
- Adaptors
- Insertion magnets
- Integrated parts
- Special formwork construction
- Battery formwork
- Concrete pump



Thanks to the expansion of the production centre and the continuing automation of manufacturing processes, we have ensured that the outstanding quality of our products will not be compromised in the future. Engineering is of the utmost importance here: the innovative capability, reliability and fast forward thinking attitude of all our employees at our headquarter in Germany triggers to find suitable solutions for our customers quickly and effectively. The bundled expertise provided by our membership of the Reymann Group means that innovations in the precast concrete industry are often incorporated into the ongoing development of our formwork components before they have even been integrated into the production processes.

Our performance philosophy is aptly expressed by the RATEC promise: Meet the better ideas!

72 WE DELIVER
OUR PRODUCTS
TO 72 DIFFERENT
COUNTRIES
WORLDWIDE



The fact that we produce our own components and even entire plants means that we can deliver a high degree of individualisation and flexibility, while it simultaneously makes us independent of suppliers and machine manufacturers.





Flexible and immobile do not have to be **contradictions in terms.** At least not for us.

For over 40 years the MTK magnet factory in Solingen and our employees there have been bywords for quality and customer satisfaction. Reputable companies use our products and development ideas, and in 2012 alone we manufactured and supplied 48,000 insertion magnets for the precast concrete industry.

We are developers, manufacturers and suppliers of high-quality products such as magnetic formwork systems, construction magnet systems and special solutions for the precast concrete industry, including individual solutions for industrial applications.

All round the world our customers value our flexibility and proximity, which we adhere to as vital components of a professional working relationship founded on partnership.

In recent years magnet technology has experienced wide-ranging and pioneering innovation, employing a major valuable contribution within the industry. However, innovation and special solutions are not our only strength: we also have an excellent track record with our range of standard products.

As a wholly owned subsidiary, MTK is an integral part of the Reymann Group.



**NO COMPANY PRODUCES
MORE MAGNETS FOR
THE PRECAST CONCRETE
INDUSTRY THAN MTK.**

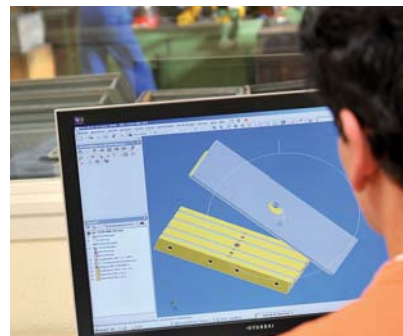

We develop and design products using such tools as our 3D-CAD workstations, which also supply the specifications for our CNC-controlled fleet of machines and associated tool construction activities.

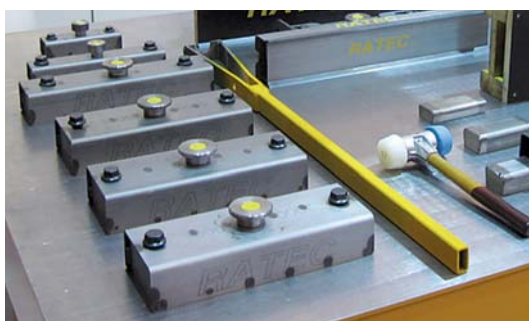

MTK 
MAGNET-FABRIK SOLINGEN



WHAT COUNTS IS PROXIMITY TO CUSTOMERS AND UNDERSTANDING THEIR NEEDS.

Mathias Reymann, President of RATEC LLC

Understanding customers means offering them better solutions.

In order to improve our service towards our North American customers and to be able to respond better to their specific needs of the market, we founded Ratec LLC in Clearwater Florida in 1996.

Since then we have firmly established ourselves on the US and Canadian markets as an expert partner in the precast concrete industry. We successfully launched our magnet technology and have positioned ourselves as a substantial provider of large-scale and special formwork.

Here we can also tap into our enterprise's 40+ years of experience and draw on our Hockenheim resources as needed, enabling us to combine German engineering know-how with the American pioneering spirit.



Standards yes, but only if we set them.

RATEC formwork systems have been used by the precast concrete element industry for years and have proven their worth under tough practical testing.

Through the ongoing development of our formwork and magnet technology, we have developed a modular system which can be used flexibly, rapidly, safely and efficiently in every field. We pursue a long-term strategy of continuous innovation whereby our products are always economical, pragmatic and forward-thinking.

The economic challenges are: reducing our formwork wood consumption, cutting the time taken to apply and remove formwork, simplifying cleaning, and improving end-product quality. Straightforward, flexible, rapid, safe and efficient positioning is guaranteed by the switchable RATEC automatic system. This employs our magnet components, which generate from 450 to 2,100 kg of magnetic force.



Special formwork according to the individual wishes of our customers, custom developed and precision manufactured.

RATEC FORMWORK IS UNIQUE

- Integrated high-performance magnets
- Flexible formwork lengths
- Height-adjustable
- Easy positioning
- Easy attachment and removal of formwork
- Set-up time < 10 minutes
- Simple crane handling
- Integrated steel-wood combinations
- Robotic handling possible



Our **change of perspective** turns precast concrete part production upside down.

upcrete® technology brings together all our expertise and know-how from the fields of building construction, factory planning, process control, workplace design and mechanical engineering.

With the upcrete® system, we set new standards for the integrated planning of work with precast concrete elements. upcrete® technology permits both the in situ production of complex concrete elements and smooth all-round form finish surfaces.

Coupled with intelligent formwork techniques and efficient pump technology, the upcrete® concreting system facilitates a highly efficient, flexible and modular production system using self-compacting concrete. Sophisticated upcrete® complete system solutions enable the production

of extremely high-quality precast concrete elements on economically viable terms.

UPCRETE® IS:

- 100% ENGINEERING FROM RATEC AND REYMANN TECHNIK.**
- 100% PRODUCED IN-HOUSE.**
- 100% KNOW-HOW GAINED FROM OVER 40 YEARS OF EXPERIENCE.**

UPCRETE® THE SYSTEM

Unique. The upcrete® concreting system (SCC is pumped into the form from beneath) sets new standards for the rational production of precast concrete elements.

Perfect. The formwork on both sides permits the achievement of hitherto unknown surface quality.

Innovative. The formwork on both sides facilitates the execution of previously impossible or prohibitively difficult geometries, such as curved or complex components. Ask about our mechanical upcrete® special moulds for your individual applications.

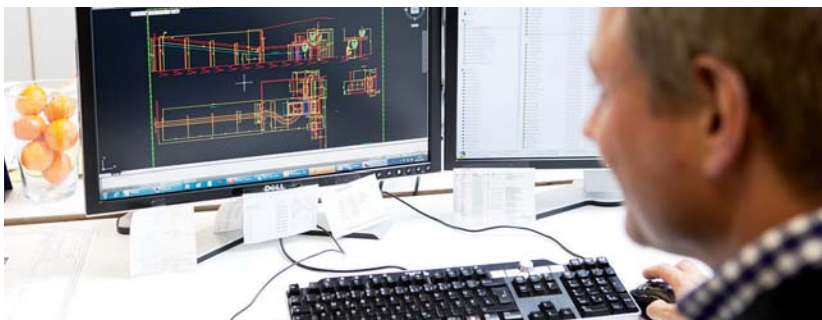



**VISION IS CONCEIVED IN
THE MIND BUT THE TRICK
IS TO DELIVER IT AT STREET
LEVEL.**

Andreas Reymann, Managing Director





UPCRETE® TECHNOLOGY IS UNRIVALLED

- Uses self-compacting concrete (SCC)
- Complete filling of even the most awkward geometries
- Formwork filled with concrete pumped upwards from below
- In situ production of complex concrete units
- Smooth form finish surfaces all round
- No screeding or smoothing of surfaces
- Minimal quantities of concrete residue
- Maximum dimensional accuracy of parts
- Quiet, minimal waste of materials, efficient and ecological concrete elements production
- Shorter formwork laying times

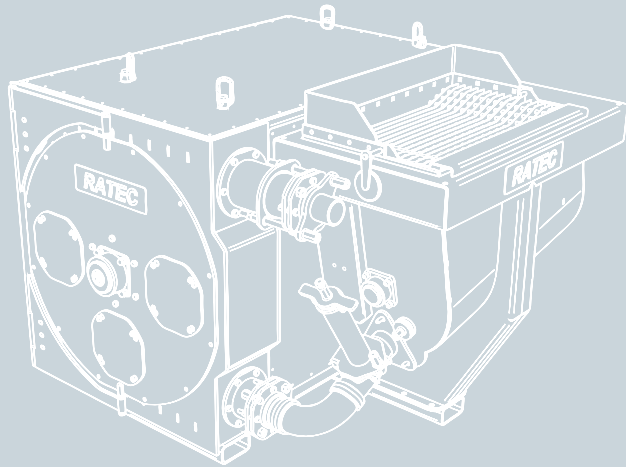

It takes only about 80 hours to go from pouring the concrete to completing a room module.



Modular housing is a good idea, and with upcrete® it's an even better one.

upcrete® ('concreting upwards') is a technique for pouring highly complex precast element geometries that combines all-round visible concrete-quality surfaces and in situ production with the highest possible degree of economic efficiency.

Consumer surveys in developing countries with fast-growing populations and a huge demand for high-quality living space led us to develop a highly efficient holistic system based on the latest materials and knowledge. The basic idea of the modular housing system is the monolithic production of a room unit which combines load-bearing walls, floors and beams. The maximum dimensions are determined both by the future residents' needs and transport limitations.

The system nevertheless offers plenty of room to manoeuvre for project developers and architects. In residential construction it permits the building of anything from terraced houses to a five-storey residential, office or school building.

It also allows the straightforward implementation of country-specific structural physics and structural engineering requirements. Special demands such as earthquake-proof construction can be met without difficulty, thus ensuring the building's stability and permanence.

Additional structural elements such as partition walls, stairs, balconies and special roof designs further enhance the system's flexibility and appeal.



Facade designs by Mario Lara for the Llasta project in Ica, Peru



SERVICES – REYMANN TECHNIK

- Development, design and engineering services for new precast plants
- Complete project management from planning to actual production
- Management and supervision for construction of turnkey facility as general contractor
- Consultation analysis of existing factories
- Supply of technical system components
- Continual productivity research and development studies provided to ensure solid future



Our credo: **Multidimensional optimisation** of all relevant factors.

With two generations of experience to build on, we can do more for your success. As the oldest independent engineering firm for the development and execution of modern precast concrete plants, we can deliver more than other planning or mechanical engineering enterprises.

Our customers benefit from our extensive experience, a factor that guarantees a high level of investment security. Our independence from machine manufacturers enables us to conduct rigorous process analyses and prepare production plans geared solely to our customers' success. Integrity, loyalty to business partners and absolute cost-benefit transparency form the foundations of our business philosophy and shape our day-to-day activities. Our customers are extremely confident in our performance proven by experience and have the awareness that they can rely on us.



Multidimensional optimisation of e.g.:

- Product challenges
- Product mix
- Capacities
- Investment
- Degree of automation
- Future prospects
- Existing restrictions
- Working conditions and more



Painstaking planning leads to straightforward solutions – even in the most difficult projects. The result in this case is the narrowest circulation plant, for wall widths up to 3.54 m, along with a reduction in personnel costs coupled with a simultaneous increase in productivity.



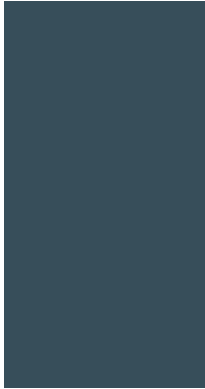
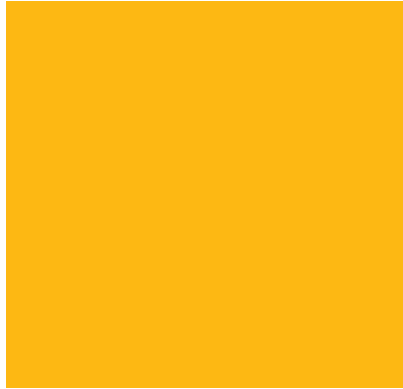



RATEC GmbH
 Karlsruher Strasse 32
 68766 Hockenheim /Germany
 Phone +49-6205-9407-29
 Fax +49-6205-9407-30
 info@ratec.org
 www.ratec.org

RATEC LLC
 6003 126th Ave North
 Clearwater, FL 33760 USA
 Phone +1-727-363-7732
 Fax +1-727-363-7463
 infoUS@ratec.org
 www.ratec.org

Reymann Technik GmbH
 Karlsruher Strasse 32
 68766 Hockenheim /Germany
 Phone +49-6205-9407-0
 Fax +49-6205-9407-20
 info@reymann-technik.de
 www.reymann-technik.de

MTK Magnet-Fabrik Solingen GmbH
 Dycker Feld 21
 42653 Solingen /Germany
 Phone +49-212-6459-88-0
 Fax +49-212-6459-88-31
 info@mtk-magnetfabrik.de
 www.mtk-magnetfabrik.de

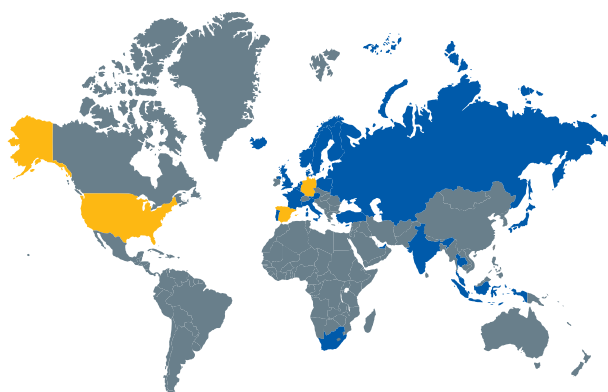

■ Headquarters ■ Distribution partners

